

Anybus X-gateway CANopen - PROFIBUS INSTALLATION SHEET



HMS Industrial Networks AB
Web: www.anybus.com
Tel: +46 35 172900
E-mail: info@hms.se



SP1191, rev 2.00, Apr 2012. AB7301

www.anybus.com

Module Front

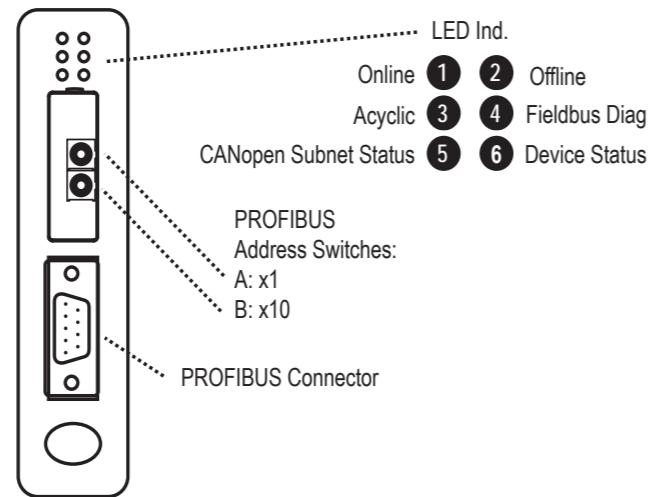

LED Indicators

LED no	Indication	Meaning
1 (Online)	Off Green Flashing green Red	Fieldbus not online Fieldbus online, data exchange possible Clear mode Application stopped
2 (Offline)	Off On (Red)	Fieldbus not offline Fieldbus offline
3 (Acyclic)	Off Green	No power or no DP-V1 request is currently being executed DP-V1 request is currently being executed
4 (Fieldbus Diag)	Off Flashing red, 1 Hz Flashing red, 2 Hz Flashing red, 4 Hz	No diagnostics present Configuration error Parameter data error Error in initialization of the communication ASIC
5 (CANopen Subnet Status) ¹	Off Flickering green/red Blinking green Single flash, green Green Blinking red Single flash, red Double flash, red Triple flash, red Quadruple flash, red Red	Power off The LSS services are in progress Pre-operational state Stopped state Operational state Configuration error Warning limit reached Error control event Sync error Data communication timeout Bus off
6 (Device Status)	Off Single flash, green Green Single flash, red Double flash, red Triple flash, red Quadruple flash, red Red	Power off Bootup Running Initialization error Timeout Hardware failure General error Fatal error

¹ This LED shows the status of the CANopen subnet that is controlled by the X-Gateway CANopen.

Accessories Checklist

The following items are required for installation:

CANopen:

- CANopen configuration tool (available at www.anybus.com)
- CANopen adapter for configuration tool (not included)
- CANopen cable (not included)
- EDS file, available at www.anybus.com

PROFIBUS Interface:

- PROFIBUS configuration tool (not included)
- PROFIBUS cable
- GSD File, available at www.anybus.com

Installation and Startup Summary

- Select baud rate and an unused node address for the interface. (Cover the switches with the enclosed switch covers.)
- Connect the gateway to the CANopen network.
- Install the EDS file in the CANopen configuration tool.
- Power up and (if required) configure the module.
- Restart the module after the CANopen interface has been configured.
- Connect the gateway to the PROFIBUS network.
- Install the GSD file in the PROFIBUS configuration tool.
- Power up and (if required) configure the module.

Please note that the module will start up as a CANopen slave. The module can be reconfigured as a CANopen master during configuration.

Side View

Setting	Baud Rate (kbit/s)
0	20
1	50
2	125
3	250
4	500
5	800
6	1000
7	Auto
8, 9	Not available

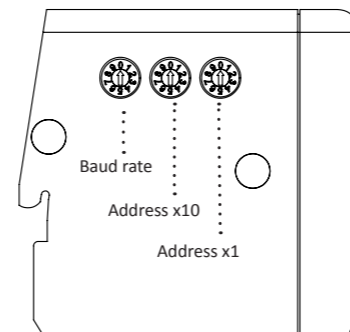

Allowed node address range is 1 - 127. Addresses 1 - 99 are available using the address rotary switches. To set e.g. node address 42, set the left address switch to 4 and the right address switch to 2. Cover the switches with the enclosed switch covers to ensure EMC compliance.

PROFIBUS Connector

Pin no	Description
1	Shield
3	B Line
4	RTS
5	GND Bus*
6	+5 V OUT*
8	A Line
Casing	PE
2, 7, 9	(not connected)

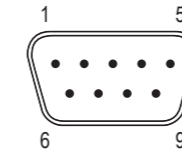

* Pins 5 and 6 are used for bus termination. Some devices, like optical transceivers (RS485 to fibre optics) may require external power supply from these pins. Such devices are not allowed to draw more than 80 mA from these power pins.

PROFIBUS Address Switches

Rotary switch	Meaning
A	Address x1
B	Address x10

Bottom View

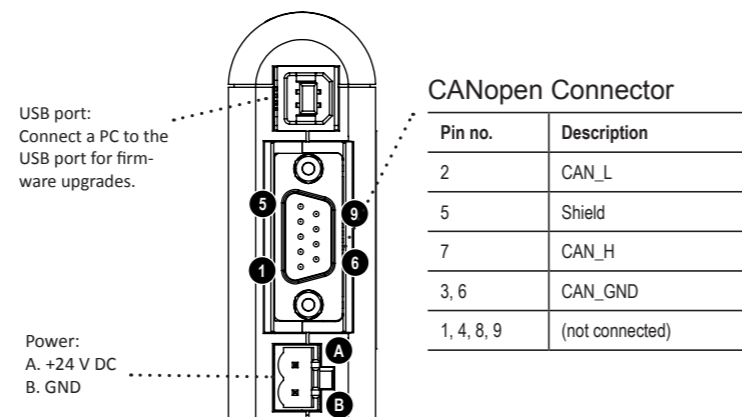

Technical Details

- Power supply:
24 V DC (-10% to +10%).
- Power consumption:
Maximum power consumption is 250 mA @ 24 V DC.
Typical power consumption: 100 mA @ 24 V DC.
- Protective Earth (PE):
Internal connection to PE via DIN-rail or.
Note: Make sure the DIN-rail is properly connected to PE.

CANopen Support

Technical support regarding the CANopen fieldbus system should be addressed to CAN in Automation (CiA).
Online: www.can-cia.org

PROFIBUS Support

Technical support regarding the PROFIBUS fieldbus system should be addressed to your local PROFIBUS User group.
Online: www.profibus.com

For maintenance and support, contact the HMS support department. Contact information is available at the support pages at www.anybus.com.

Further information and documents about this product can be found at the product pages on www.anybus.com.

Anybus X-gateway CANopen INSTALLATION SHEET

DIN-rail Mounting

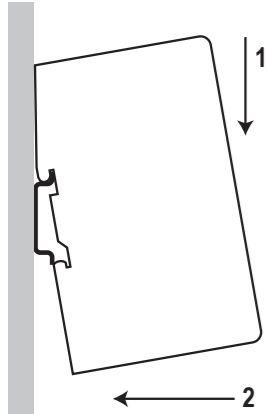

To snap the gateway on, first press it downwards (1) to compress the spring in the DIN-rail mechanism, then push it against the DIN-rail as to make it snap on (2).

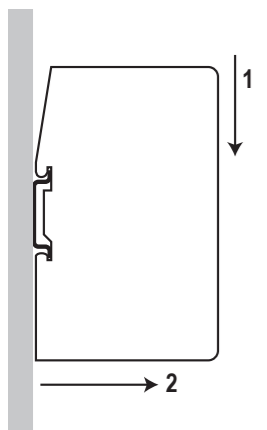

To snap the gateway off, push it downwards (1) and pull it out from the DIN-rail (2), as to make it snap off from the DIN-rail.

Additional Installation and Operating Instructions

Supply voltage: The X-gateway requires a regulated 24 V (21.6 V to 26.4 V) DC power source.

Field wiring terminal markings (wire type (Cu only, 14-30AWG)
"Use 60/75 or 75°C copper (CU) wire only"
Terminal tightening torque (5-7 lb-in (0.5 - 0.8 Nm)).

Use in Overvoltage Category I Pollution Degree 2 Environment.

Install in an enclosure considered representative of the intended use. To comply with ATEX directives, the equipment must be installed within an IP54 enclosure and must be installed with a transient suppressor on the supply that does not exceed 140% (33.6 V DC) of the nominal rated supply voltage.

Operating temperature/Surrounding temperature:
-25 to +55 degrees C @ 250 mA @ 24 V DC.

Maximum surface temperature: 135 degrees C.

Pressure: 850 - 1050 millibar.

This product is designed to safely operate in class I, division 2 Hazardous location according to ANSI/ISA 12.12.01-2011 and category 3, zone 2 according to EN 60079-0, EN 60079-11, and EN 60079-15.

SUITABLE FOR USE IN CLASS I, DIVISION 2, GROUPS A, B, C AND D HAZARDOUS LOCATIONS, OR NONHAZARDOUS LOCATIONS ONLY.

Warnings

- **WARNING - EXPLOSION HAZARD - SUBSTITUTION OF ANY COMPONENTS MAY IMPAIR SUITABILITY FOR CLASS I, DIVISION 2.**
- **WARNING - EXPLOSION HAZARD - WHEN IN HAZARDOUS LOCATIONS, TURN OFF POWER BEFORE REPLACING OR WIRING MODULES.**
- **WARNING - EXPLOSION HAZARD - DO NOT DISCONNECT EQUIPMENT WHILE THE CIRCUIT IS LIVE OR UNLESS THE AREA IS KNOWN TO BE FREE OF IGNITABLE CONCENTRATIONS.**
- **WARNING - EXPLOSION HAZARD - THE USB CONNECTOR IS NOT FOR USE IN HAZARDOUS LOCATIONS AND FOR TEMPORARY CONNECTION ONLY. DO NOT USE, CONNECT OR DISCONNECT UNLESS THE AREA IS KNOWN TO BE NONHAZARDOUS. CONNECTION OR DISCONNECTION IN AN EXPLOSIVE ATMOSPHERE COULD RESULT IN AN EXPLOSION.**
- **WARNING - INSTALL IN AN ENCLOSURE CONSIDERED REPRESENTATIVE OF THE INTENDED USE. TO COMPLY WITH ATEX DIRECTIVES, THE EQUIPMENT MUST BE INSTALLED WITHIN AN IP54 ENCLOSURE AND MUST BE INSTALLED WITH A TRANSIENT SUPPRESSOR ON THE SUPPLY THAT DOES NOT EXCEED 140% (33.6 V DC) OF THE NOMINAL RATED SUPPLY VOLTAGE.**

UL Certification



LISTED 67AM

Atex Certification

EX nA ic IIC T4 Gc



DEMKO 12 ATEX 1062548X

EMC Compliance (CE)



This product is in accordance with the EMC directive 2004/108/EC through conformance with the following standards:

- **EN 61000-6-4 (2007)**
Emission standard for industrial environment
EN 55016-2-3, Class A (2006)
- **EN 61000-6-2 (2005)**
Immunity for industrial environment
EN 61000-4-2 (2009)
EN 61000-4-3 (2006)
EN 61000-4-4 (2004)
EN 61000-4-5 (2005)
EN 61000-4-6 (2007)

Label Markings

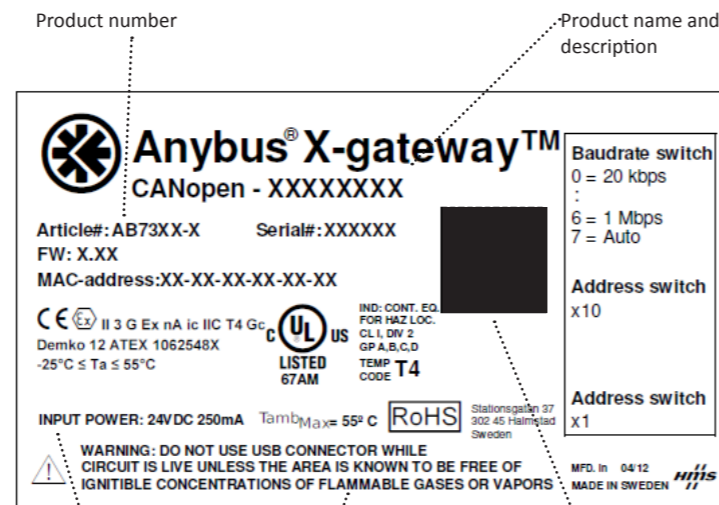

Surrounding air temperature and electrical ratings

Warnings

Product information bar code

HMS Industrial Networks AB
Stationsgatan 37
302 45 Halmstad
Sweden



Further information and documents about this product can be found at the product pages on www.anybus.com.