

Concept

The Anybus X-gateway acts as a translation device between two different fieldbus networks.

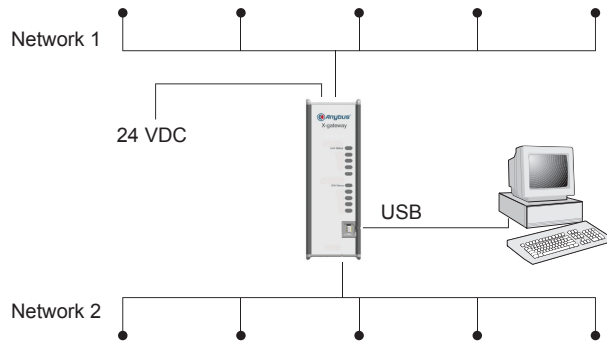

Internally the gateway consists of two separate network interfaces, mounted at the top and bottom end of the gateway respectively, and a translation device handling communication between the interfaces. For more information about the specific interfaces, please refer to the **Network Installation Sheet** for each fieldbus network.

Top view

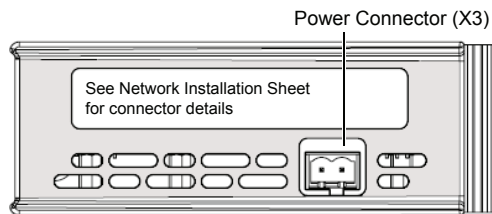

Bottom view

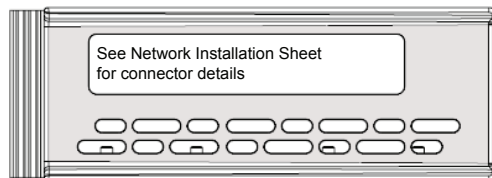

Front view

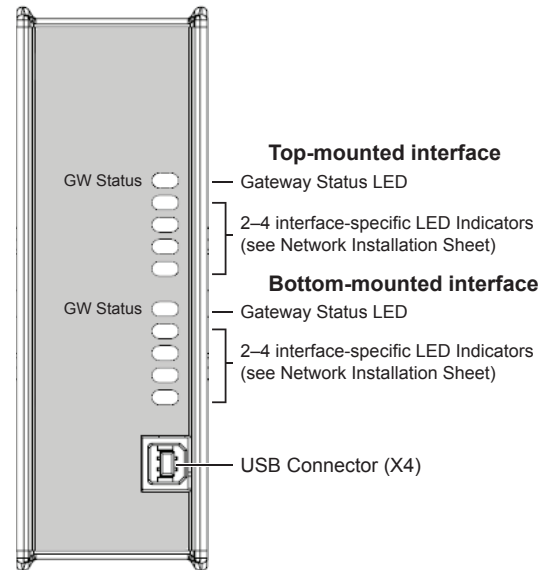

Gateway Status LED

Indication	Meaning
Green	Communication running
Red	Communication error
Red (flashing)	Network interface error

The interface-specific LED indicators are described in the Network Installation Sheets for the respective fieldbus network interfaces.

Power Connector (X3)

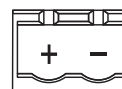

Pin	Signal
+	24 VDC \pm 20 % Class 2
-	Ground

DIN Rail Mounting (standard)

Align the gateway with the DIN rail connector, then press firmly on the top end and push the lower end into place.

To dismantle the gateway, press firmly on the top end, then pull the lower end away from the DIN rail.

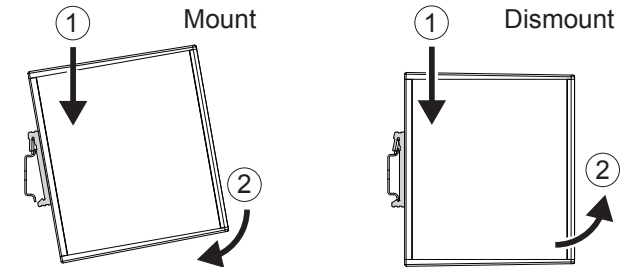

DIN Rail Mounting (sideways)

Remove the sticker covering the screw holes on the right side panel. Unscrew the DIN clip from the back and refit it to the side panel.

Mount/dismount the gateway the same way as in standard mounting.

Screw holes behind sticker

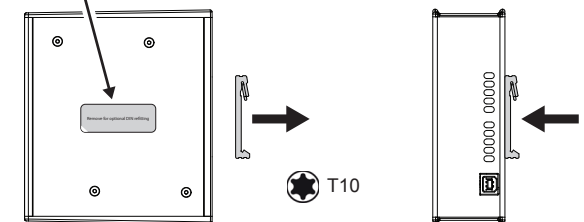

Technical Specifications

Power supply	24 VDC \pm 20 % Class 2
Power consumption	200 mA at 24 VDC (typical) 400 mA at 24 VDC (maximum)
Operating temperature	-25 to +65 °C @ 400 mA/24 VDC
Non-operating temperature	-40 to +85 °C
Relative humidity	5-95 % non-condensing
Protective Earth (PE)	Internal connection to PE via the DIN rail

Technical Support

Technical support, documentation and software downloads are available at www.anybus.com.

