

X-Gateway Interface Addendum Interbus Fibre Optic Slave

Doc: HMSI-27-260

Rev: 2.00



HALMSTAD • CHICAGO • KARLSRUHE • TOKYO • BEIJING • MILANO • MULHOUSE • COVENTRY • PUNE • COPENHAGEN

HMS Industrial Networks
Mailing address: Box 4126, 300 04 Halmstad, Sweden
Visiting address: Stationsgatan 37, Halmstad, Sweden

E-mail: info@hms-networks.com
www.hms-networks.com

Important User Information

This document is intended to provide a good understanding of the functionality offered by the Interface described here.

The reader is expected to be familiar with high level software design, and communication systems in general. The use of advanced interface-specific functionality may require in-depth knowledge of networking internals and/or information from the network specifications. In such cases, the persons responsible for the implementation of this product should either obtain the necessary specifications to gain sufficient knowledge, or alternatively limit the implementation in such a way that this is not necessary.

Liability

Every care has been taken in the preparation of this manual. Please inform HMS Industrial Networks AB of any inaccuracies or omissions. The data and illustrations found in this document are not binding. We, HMS Industrial Networks AB, reserve the right to modify our products in line with our policy of continuous product development. The information in this document is subject to change without notice and should not be considered as a commitment by HMS Industrial Networks AB. HMS Industrial Networks AB assumes no responsibility for any errors that may appear in this document.

There are many applications of this product. Those responsible for the use of this device must ensure that all the necessary steps have been taken to verify that the applications meet all performance and safety requirements including any applicable laws, regulations, codes, and standards.

HMS Industrial Networks AB will under no circumstances assume liability or responsibility for any problems that may arise as a result from the use of undocumented features, timing, or functional side effects found outside the documented scope of this product. The effects caused by any direct or indirect use of such aspects of the product are undefined, and may include e.g. compatibility issues and stability issues.

The examples and illustrations in this document are included solely for illustrative purposes. Because of the many variables and requirements associated with any particular implementation, HMS Industrial Networks AB cannot assume responsibility for actual use based on these examples and illustrations.

Intellectual Property Rights

HMS Industrial Networks AB has intellectual property rights relating to technology embodied in the product described in this document. These intellectual property rights may include patents and pending patent applications in the US and other countries.

Trademark Acknowledgements

Anybus ® is a registered trademark of HMS Industrial Networks AB. All other trademarks are the property of their respective holders.

!

WARNING: This is a class A product. in a domestic environment this product may cause radio interference in which case the user may be required to take adequate measures.

ESD Note: This product contains ESD (Electrostatic Discharge) sensitive parts that may be damaged if ESD control procedures are not followed. Static control precautions are required when handling the product. Failure to observe this may cause damage to the product.

Table of Contents

Preface	About This Document	
	How To Use This Document	P-3
	Important User Information	P-3
	Related Documents.....	P-4
	Document History	P-4
	Conventions & Terminology.....	P-4
	Support	P-4
 Chapter 1	 About the Interbus Fibre Optic Slave Interface	
	General Description.....	1-5
	Features.....	1-5
	External View	1-6
	<i>Interface Status LEDs</i>	1-6
	<i>Interface Connectors</i>	1-6
 Chapter 2	 Data Exchange	
	General Information.....	2-7
	Input Data (Gateway to Interbus)	2-7
	Output Data (Interbus to Gateway).....	2-8
	PCP Object Mapping.....	2-8
	<i>Output Buffer</i>	2-8
	<i>Input Buffer</i>	2-9
 Chapter 3	 Installation and Configuration	
	Node Address Configuration	3-10
	Operating Baudrate.....	3-10
	Network Configuration	3-10
 Appendix A	 Calculating the PCP Transmission Time	
 Appendix B	 Technical Specification	
	Network Interface Details	B-12

P. About This Document

P.1. How To Use This Document

This document describes network specific features and procedures needed when operating the Interbus Fibre Optic Slave Interface for the Anybus X-Gateway. For general information and operating instructions for the Anybus X-Gateway, consult the Anybus-X Generic Gateway User Manual.

The reader of this document is expected to be familiar with Interbus networking technology, and communication systems in general.

For further information, documentation etc., please visit www.anybus.com.

P.2. Related Documents

Document	Author
Anybus-X Generic Gateway User Manual	HMS
Anybus-S Interbus 2Mbit Fibre Optic Fieldbus Appendix	HMS
Interbus Fibre Optic Slave Interface, Installation Sheet	HMS

P.3. Document History

Revision List

Revision	Date	Author	Chapter	Description
1.00	2004-04-02	PeP	All	First release
1.01	2007-06-14	PeP	All	General update
2.00	May 2014	SDa	All	New hardware and Anybus Configuration Manager

P.4. Conventions & Terminology

The following conventions are used throughout this document:

- Numbered lists provide sequential steps
- Bulleted lists provide information, not procedural steps
- The term 'X-Gateway' refers to the Anybus X-Gateway
- The term 'Slave interface' refers to the Interbus Fibre Optic Slave interface for the X-Gateway.
- The term 'user manual' refers to the Anybus-X Generic Gateway User Manual.
- Hexadecimal values are written in the format NNNNh, where NNNN is the hexadecimal value.
- 16/32 bit values are generally stored in Motorola (big endian) format unless otherwise stated.

P.5. Support

For general contact information and support, please refer to the contact and support pages at www.anybus.com.

1. About the Interbus Fibre Optic Slave Interface

1.1. General Description

The Interbus Fibre Optic Slave interface for the Anybus X-Gateway acts as a slave node that can be read from/written to by an Interbus master. It supports up to 10 words of Process Data in each direction, and can optionally use one word for the PCP communication channel, providing up to 512 bytes of slower PCP object data in each direction.

Like all X-Gateway interfaces, the Interbus Fibre Optic Slave interface exchanges data via two buffers as follows:

- **Input Buffer**
This buffer holds data forwarded *from* the other network, i.e. data which is read by the Interbus master.
- **Output Buffer**
This buffer is forwarded *to* the other network, i.e. data which is written by the Interbus master.

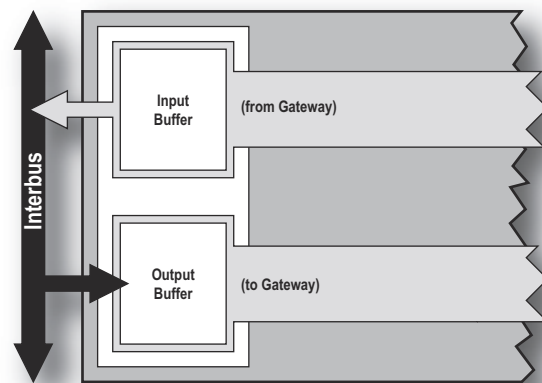

1.2. Features

- Optical Interbus Interface
- 500kbit/s and 2Mbit/s operation
- Up to 10 words of Process Data in each direction
- PCP v2.0 (0 or 1 word)

1.3. External View

1.3.1. Interface Status LEDs

LED	Colour	Indication
Gateway Status		See the user manual for further details.
BA	Green	Bus active
RD	Yellow	Remote bus disabled
FO2	Yellow	Fibre optic warning for Bus Out
FO1	Yellow	Fibre optic warning for Bus In

1.3.2. Interface Connectors

#	Description
1	Fibre optic transmit (Bus In)
2	Fibre optic receive (Bus In)
3	Fibre optic transmit (Bus Out)
4	Fibre optic receive (Bus Out)
5	Baudrate jumper. See "Operating Baudrate" on page 10.
6	Gateway power connector Consult the X-gateway user manual for further details.

For further details on the **USB Gateway Config connector**, see the X-gateway user manual.

Front View

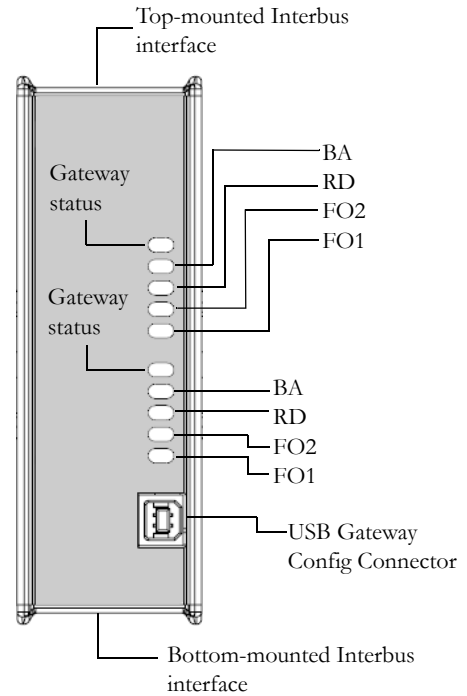

Top-mounted Interface

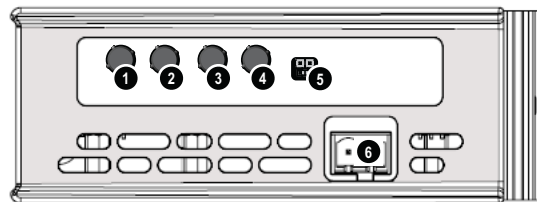

Bottom-mounted Interface

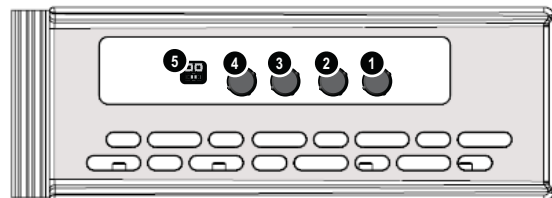

2. Data Exchange

2.1. General Information

On Interbus, network data is represented as Process Data and PCP. The Slave interface supports up to 10 words of data in each direction, out of which 1 word may be used internally for the PCP communication channel.

The amount of Process Data and PCP is specified through the Gateway Config Interface. Note that specifying 10 words of Process Data effectively shuts down the PCP channel, preventing PCP communication altogether.

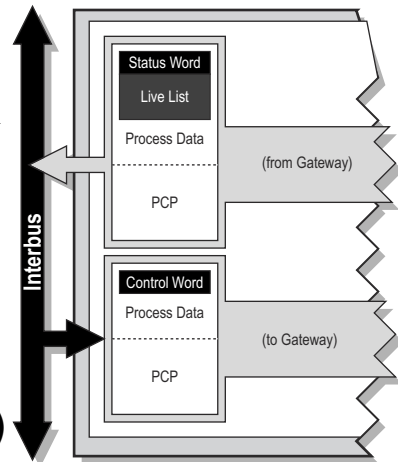

2.2. Input Data (Gateway to Interbus)

Depending on the type of gateway and how it has been configured, up to 5 words of the data produced by the gateway may be occupied with status information.

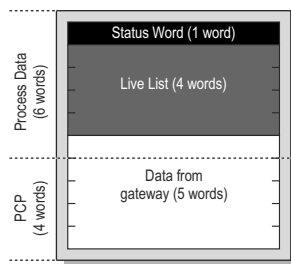

Example A:

- Process Data size = 6 words (12 bytes)
- PCP size = 4 (8 bytes)
- Live List = Enabled
- Control & Status Word = Enabled

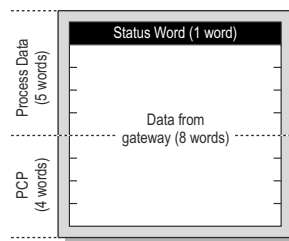

Example B:

- Process Data size = 5 words (10 bytes)
- PCP size = 4 words (8 bytes)
- Live List = Disabled
- Control & Status Word = Enabled

Note: The Live List is only available on master-slave gateway versions.

2.3. Output Data (Interbus to Gateway)

Depending on how the gateway is configured, the first word consumed by the gateway may be interpreted as control information (i.e. the Control Word).

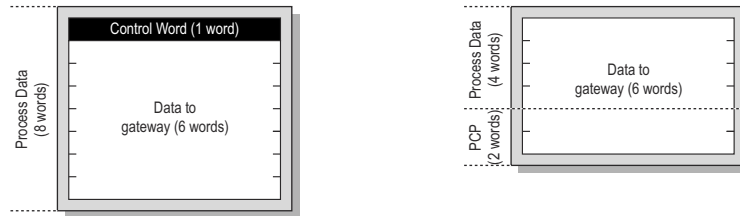

Example A:

Process Data size = 8 words (16 bytes)
PCP size = 0
Control Word = Enabled

Example B:

Process Data size = 4 words (8 bytes)
PCP size = 2 words (4 bytes)
Control Word = Disabled

Note: The Live List is only available on master-slave gateway versions.

2.4. PCP Object Mapping

2.4.1. Output Buffer

The PCP data in the Output Buffer is linearly mapped to PCP objects as follows:

PCP byte no. (Output Buffer)	Mapped to PCP Object...	Contents
0	6000h	Array of (up to) 32 bytes
1		
...		
31		
32	6001h	Array of (up to) 32 bytes
33		
...		
63		
...
480	600Fh	Array of (up to) 32 bytes
481		
...		
511		

Note: The Slave Interface will only map the amount of data that is actually in use. For example, an output PCP size of 48 bytes results in two objects; 6000h (Array of 32 bytes) and 6001h (Array of 16 bytes).

2.4.2. Input Buffer

The PCP data in the Input Buffer is linearly mapped to PCP objects as follows:

PCP byte no. (Input Buffer)	Mapped to PCP Object...	Contents
0	6040h	Array of (up to) 32 bytes
1		
...		
31		
32	6041h	Array of (up to) 32 bytes
33		
...		
63		
...
480	604Fh	Array of (up to) 32 bytes
481		
...		
511		

Note: The Slave Interface will only map the amount of data that is actually in use. For example, an input PCP size of 40 bytes results in two objects; 6040h (Array of 32 bytes) and 6041h (Array of 8 bytes).

3. Installation and Configuration

3.1. Node Address Configuration

Unlike most other network systems, Interbus does not use any switches etc. to set the node address. Instead, each node is automatically assigned a node address based on its physical location in the network.

3.2. Operating Baudrate

The Slave interface supports two baudrates; 500kbps and 2Mbps. The baudrate is specified using the on-board jumper, see “Interface Connectors” on page 6.

Note: Depending on if the Slave interface is top or bottom-mounted, the orientation of the jumper will be different.

3.3. Network Configuration

Normally, an Interbus network is self-configuring, i.e. provided that the Slave interface is set to operate at the same baudrate as the rest of the system, the interface should be detected and added automatically.

Note however that PCP communication will require support in the Interbus master.

A. Calculating the PCP Transmission Time

The formula below can be used to calculate the PCP transmission times.

Formula:

$$TD = TL + Gm(OD, N) * Z + TL7$$

$$Gm(OD, N) = ((N + OD - 1) / m) + 1$$

TD	Transmission time of a PCP service in milliseconds
TL	Latency 2 * Z (milliseconds)
OD	Service dependent overhead
N	User data
Z	Interbus cycle time (milliseconds)
TL7	Layer 7 runtime typical 4.0 milliseconds
m	Width of parameter channel (in bytes) - 1 (control information) ¹
Gm(OD, N)	Number of cycles that are required to transmit the overhead and user data

The division through 'm' should be an integer division.

Example:

Write Request:	Read Response:
m = 1 (fixed)	m = 1 (fixed)
OD = 7 bytes for one write request	OD = 4 bytes for a read response
N = 128 bytes (e.g. one parameter set)	N = 0 bytes (no user data)
Z = 1.5 ms	Z = 1.5 ms
Gm = 135 cycles	Gm = 4 cycles
Td = 209.5 ms	Td = 13 ms

1. The Interbus-S Slave interface for the X-Gateway uses a fixed size of 1 word (2 bytes) for PCP communication, hence 'm' shall be 1.

B. Technical Specification

B.1. Network Interface Details

- **Device Type**
Remote-Bus-Device
- **Device Class**
Digital, or PCP enabled (depends on if PCP Data is used)
- **Processdata Direction**
Default is both (depends on the I/O configuration in the gateway)
- **Process Data Length**
Default is 20 Byte input and 20 Byte output.
- **ID-Codes (Identcode)**

#	Description
01h	digital module with output data (DO)
02h	digital module with input data (DI)
03h	digital module with input and output data (DIO)
F3h	module with parameter channel (1 PCP word)