

Anybus X-gateway CANopen - EtherNet/IP INSTALLATION SHEET



HMS Industrial Networks AB
Web: www.anybus.com
Tel: +46 35 172900
E-mail: info@hms.se



SP1196, Rev 2.10, AB7306.

www.anybus.com

Module Front

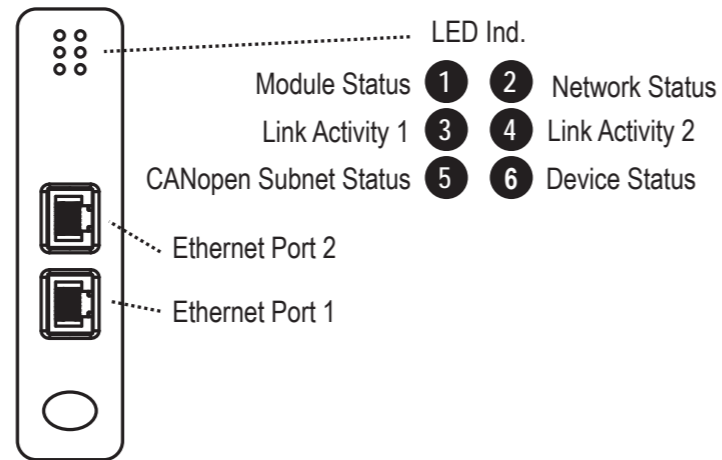

Ethernet/IP Connector

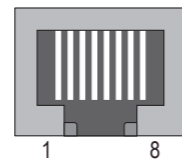

Pin no	Description
1	TD+
2	TD-
3	RD+
6	RD-
4, 5, 7, 8	(reserved)

LED Indicators

LED no	Indication	Meaning
1 (Module Status)	Off	No power
	Green	Controlled by a scanner in Run state
	Flashing green	Not configured or scanner in Idle state
	Flashing red	Minor fault, recoverable
	Red	Major fault, unrecoverable
2 (Network Status)	Off	Self test in progress
	No IP address	
	Green	On-line, one or more connections established (CIP Class 1 or 3)
	Flashing green	On-line, no connection established
	Flashing red	One or more connections timed out (CIP Class 1 or 3)
3 (Link activity 1) 4 (Link activity 2)	Red	Duplicate IP address, fatal error
	Flashing green/red	Self test in progress
	Off	No link sensed on port 1/2
5 (CANopen Subnet Status) ¹	Flashing green	Activity, receiving/transmitting Ethernet packets at 100 Mbps
	Flashing yellow	Activity, receiving/transmitting Ethernet Packets at 10 Mbps
	Off	Power off
	Flickering green/red	The LSS services are in progress
	Blinking green	Pre-operational state
6 (Device Status)	Single flash, green	Stopped state
	Green	Operational state
	Blinking red	Configuration error
	Single flash, red	Warning limit reached
	Double flash, red	Error control event
	Triple flash, red	Sync error
	Quadruple flash, red	Data communication timeout
	Red	Bus off
	Off	Power off
	Single flash, green	Bootup
Green	Running	
Single flash, red	Initialization error	
Double flash, red	Timeout	
Triple flash, red	Hardware failure	
Quadruple flash, red	General error	
Red	Fatal error	

1. This LED shows the status of the CANopen subnet that is controlled by the X-Gateway CANopen.

Accessories Checklist

The following items are required for installation:

CANopen:

- CANopen configuration tool (available at www.anybus.com)
- CANopen adapter for configuration tool (not included)
- CANopen cable (not included)
- EDS file, available at www.anybus.com

EtherNet/IP Interface:

- Ethernet cable and connector (not included)
- Configuration tool (not included)

Installation and Startup Summary

- Select baud rate and an unused node address for the interface. (Cover the switches with the enclosed switch covers.)
- Connect the gateway to the CANopen network.
- Install the EDS file in the CANopen configuration tool.
- Power up and (if required) configure the module.
- Restart the module after the CANopen interface has been configured.
- Connect the gateway to the Ethernet network.
- Power up and (if required) configure the module.

Please note that the module will start up as a CANopen slave. The module can be reconfigured as a CANopen master during configuration.

Side View

Setting	Baud Rate (kbit/s)
0	20
1	50
2	125
3	250
4	500
5	800
6	1000
7	Auto
8, 9	Not available

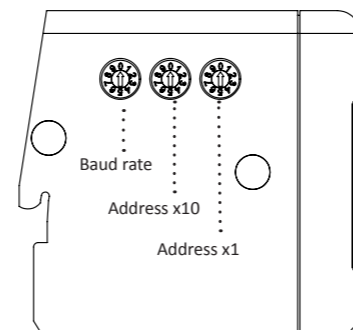

Allowed node address range is 1 - 127. Addresses 1 - 99 are available using the address rotary switches. To set e.g. node address 42, set the left address switch to 4 and the right address switch to 2. Cover the switches with the enclosed switch covers to ensure EMC compliance.

Bottom View

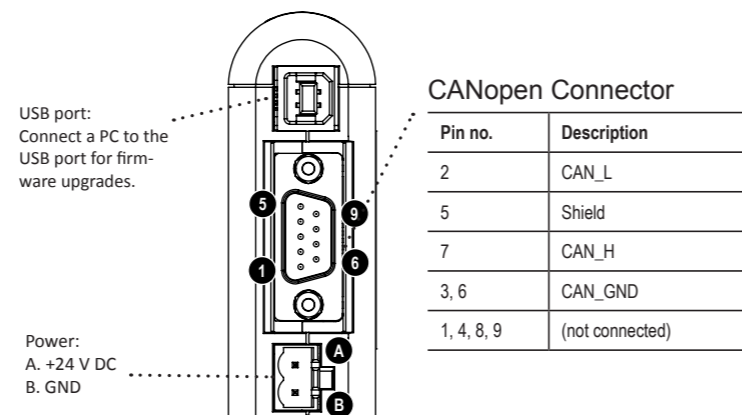

USB port:
Connect a PC to the USB port for firm-ware upgrades.

Power:
A. +24 V DC
B. GND

CANopen Connector

Pin no.	Description
2	CAN_L
5	Shield
7	CAN_H
3, 6	CAN_GND
1, 4, 8, 9	(not connected)

Technical Details

- Power supply:
24 V DC (-10% to +10%).
- Power consumption:
Maximum power consumption is 250 mA @ 24 V DC.
Typical power consumption: 100 mA @ 24 V DC.
- Protective Earth (PE):
Internal connection to PE via DIN-rail or, if the DIN-rail can not be used, via the power connector.
Note: Make sure the DIN-rail is properly connected to PE.

CANopen Support

Technical support regarding the CANopen fieldbus system should be addressed to CAN in Automation (CiA).
Online: www.can-cia.org

EtherNet/IP Support

Technical questions regarding the EtherNet/IP fieldbus system should be addressed to the ODVA.
Online: www.odva.com

For maintenance and support, contact the HMS support department. Contact information is available at the support pages at www.anybus.com.

Further information and documents about this product can be found at the product pages on www.anybus.com.

Anybus X-gateway CANopen INSTALLATION SHEET

DIN-rail Mounting

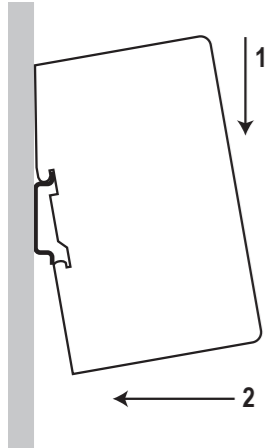

To snap the gateway on, first press it downwards (1) to compress the spring in the DIN-rail mechanism, then push it against the DIN-rail as to make it snap on (2).

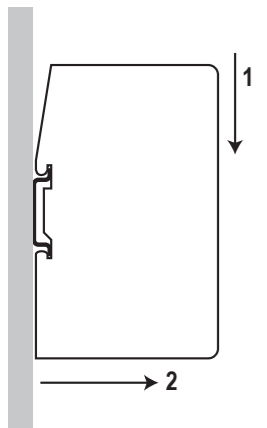

To snap the gateway off, push it downwards (1) and pull it out from the DIN-rail (2), as to make it snap off from the DIN-rail.

Additional Installation and Operating Instructions

Supply voltage: The X-gateway requires a regulated 24 V (21.6 V to 26.4 V) DC power source.

Field wiring terminal markings (wire type (Cu only, 14-30AWG) "Use 60/75 or 75°C copper (CU) wire only")
Terminal tightening torque (5-7 lb-in (0.5 - 0.8 Nm)).

Use in Overvoltage Category I Pollution Degree 2 Environment.

Install in an enclosure considered representative of the intended use. To comply with ATEX directives, the equipment must be installed within an IP54 enclosure and must be installed with a transient suppressor on the supply that does not exceed 140% (33.6 V DC) of the nominal rated supply voltage.

Operating temperature/Surrounding temperature:
-25 to +55 degrees C @ 250 mA @ 24 V DC.

Maximum surface temperature: 135 degrees C.

Pressure: 850 - 1050 millibar.

This product is designed to safely operate in class I, division 2 Hazardous location according to ANSI/ISA 12.12.01-2011 and category 3, zone 2 according to EN 60079-0, EN 60079-11, and EN 60079-15.

SUITABLE FOR USE IN CLASS I, DIVISION 2, GROUPS A, B, C AND D HAZARDOUS LOCATIONS, OR NONHAZARDOUS LOCATIONS ONLY.

ODVA Compliance



ControlNet CONFORMANCE TESTED™ is a certification mark of ODVA.



DeviceNet CONFORMANCE TESTED™ is a certification mark of ODVA.



EtherNet/IP CONFORMANCE TESTED™ is a certification mark of ODVA.

Warnings

- **WARNING - EXPLOSION HAZARD - SUBSTITUTION OF ANY COMPONENTS MAY IMPAIR SUITABILITY FOR CLASS I, DIVISION 2.**
- **WARNING - EXPLOSION HAZARD - WHEN IN HAZARDOUS LOCATIONS, TURN OFF POWER BEFORE REPLACING OR WIRING MODULES.**
- **WARNING - EXPLOSION HAZARD - DO NOT DISCONNECT EQUIPMENT WHILE THE CIRCUIT IS LIVE OR UNLESS THE AREA IS KNOWN TO BE FREE OF IGNITABLE CONCENTRATIONS.**
- **WARNING - EXPLOSION HAZARD - THE USB CONNECTOR IS NOT FOR USE IN HAZARDOUS LOCATIONS AND FOR TEMPORARY CONNECTION ONLY. DO NOT USE, CONNECT OR DISCONNECT UNLESS THE AREA IS KNOWN TO BE NONHAZARDOUS. CONNECTION OR DISCONNECTION IN AN EXPLOSIVE ATMOSPHERE COULD RESULT IN AN EXPLOSION.**
- **WARNING - INSTALL IN AN ENCLOSURE CONSIDERED REPRESENTATIVE OF THE INTENDED USE. TO COMPLY WITH ATEX DIRECTIVES, THE EQUIPMENT MUST BE INSTALLED WITHIN AN IP54 ENCLOSURE AND MUST BE INSTALLED WITH A TRANSIENT SUPPRESSOR ON THE SUPPLY THAT DOES NOT EXCEED 140% (33.6 V DC) OF THE NOMINAL RATED SUPPLY VOLTAGE.**

UL Certification



LISTED 67AM

Atex Certification

EX nA ic IIC T4 Gc



DEMKO 12 ATEX 1062548X

Label Markings

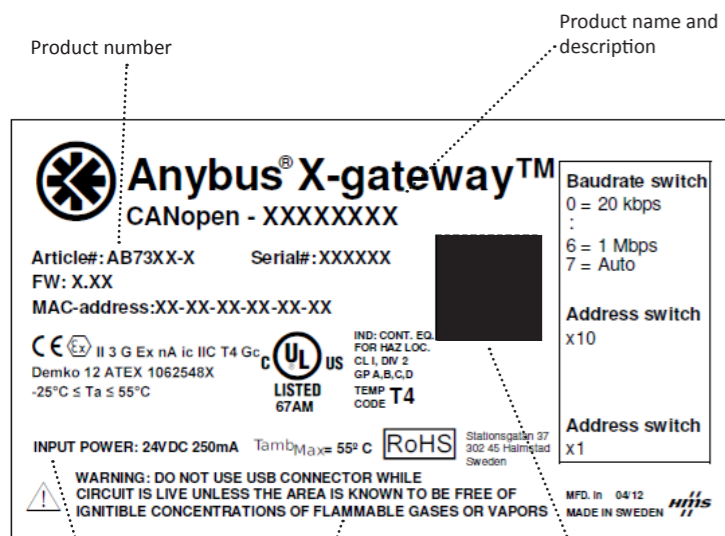

EMC Compliance (CE)



This product is in accordance with the EMC directive 2004/108/EC through conformance with the following standards:

- **EN 61000-6-4 (2007)**
Emission standard for industrial environment
EN 55016-2-3, Class A (2006)
- **EN 61000-6-2 (2005)**
Immunity for industrial environment
EN 61000-4-2 (2009)
EN 61000-4-3 (2006)
EN 61000-4-4 (2004)
EN 61000-4-5 (2005)
EN 61000-4-6 (2007)

HMS Industrial Networks AB
Stationsgatan 37
302 45 Halmstad
Sweden



Further information and documents about this product can be found at the product pages on www.anybus.com.

Warnings

- **ATTENTION – RISQUE D'EXPLOSION – LE REMPLACEMENT DE TOUT COMPOSANTS INVALIDE LA CERTIFICATION CLASS I, DIVISION 2.**
- **ATTENTION – RISQUE D'EXPLOSION – EN ZONE EXPLOSIVE, VEUILLEZ COUPER L'ALIMENTATION ÉLECTRIQUE AVANT LE REMPLACEMENT OU LE RACCORDEMENT DES MODULES.**
- **ATTENTION – RISQUE D'EXPLOSION – NE PAS DÉCONNECTER L'ÉQUIPEMENT TANT QUE L'ALIMENTATION EST TOUJOURS PRÉSENTE OU QUE LE PRODUIT EST TOUJOURS EN ZONE EXPLOSIVE ACTIVE.**
- **ATTENTION – RISQUE D'EXPLOSION – LE CONNECTEUR USB NE PEUT ÊTRE UTILISÉ MÊME POUR UN USAGE OCCASIONNEL EN ZONE EXPLOSIVE, BRANCHER ET DÉBRANCHER IMPÉRATIVEMENT HORS ZONE, LE BRANCHEMENT ET LE DÉBRANCHEMENT EN ZONE EST SUSCEPTIBLE DE PROVOQUER UNE EXPLOSION.**
- **ATTENTION – L'INSTALLATION DOIT ÊTRE CONFORME AUX EXIGENCES FIXÉES PAR LES DIRECTIVES ATEX, L'ÉQUIPEMENT DOIT IMPÉRATIVEMENT ÊTRE INSTALLÉ DANS UN COFFRET IP54 ET DONT L'ALIMENTATION NE DOIT PAS DÉPASSER 140% (33,6 V DC) DE LA TENSION NOMINALE.**